

Attention

NLP: Fall 2023

Anoop Sarkar

Machine Translation

$$\arg \max_{\mathbf{y}} p(\mathbf{y} \mid \mathbf{x})$$

Target language

Source language

Neural Machine Translation

$$\arg \max_{\mathbf{y}} p(\mathbf{y} \mid \mathbf{x}) = \prod_{t=1}^T p(y_t \mid \{y_1, \dots, y_{t-1}\}, c),$$

$$\mathbf{y} = (y_1, \dots, y_{T_y}). \quad c = q(\{h_1, \dots, h_{T_x}\})$$

$$\mathbf{x} = (x_1, \dots, x_{T_x}). \quad h_i \text{ is a vector representation of } x_i$$

c is a vector assembled from all the h_i vectors

s_i is a vector representation of y_i

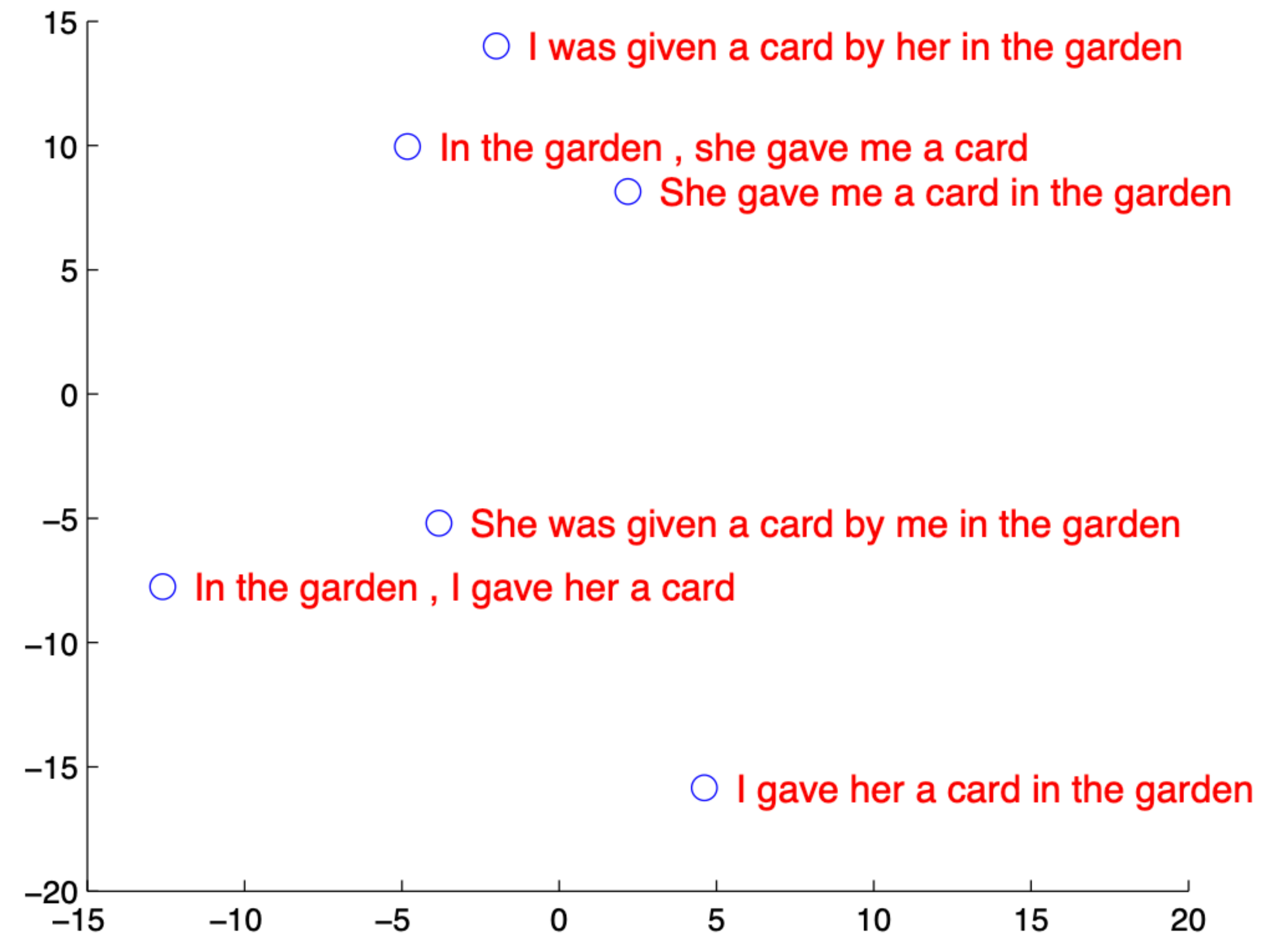
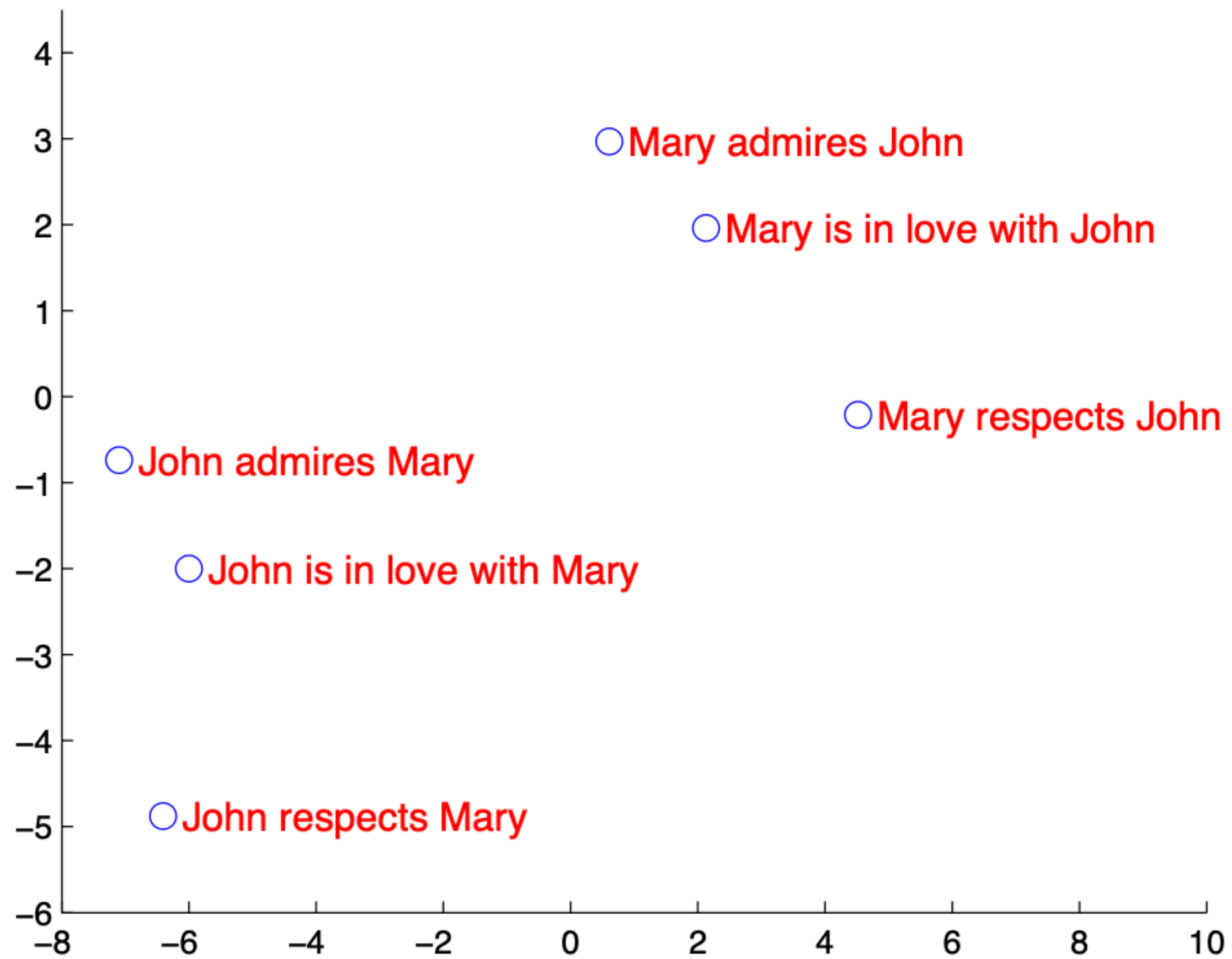

NEURAL MACHINE TRANSLATION BY JOINTLY LEARNING TO ALIGN AND TRANSLATE

Dzmitry Bahdanau

Jacobs University Bremen, Germany

KyungHyun Cho **Yoshua Bengio***

Université de Montréal

ICLR 2015

<https://arxiv.org/abs/1409.0473>

Attention Networks in Neural Machine Translation

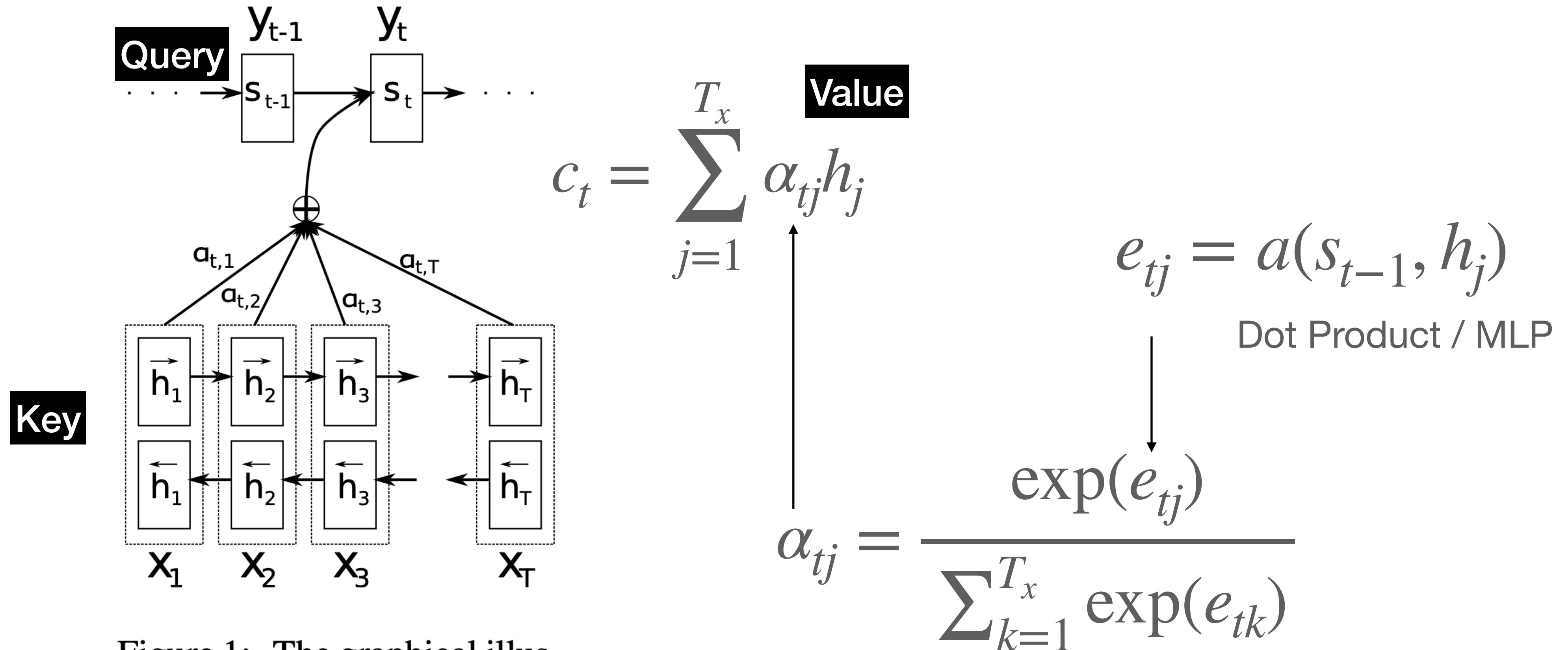
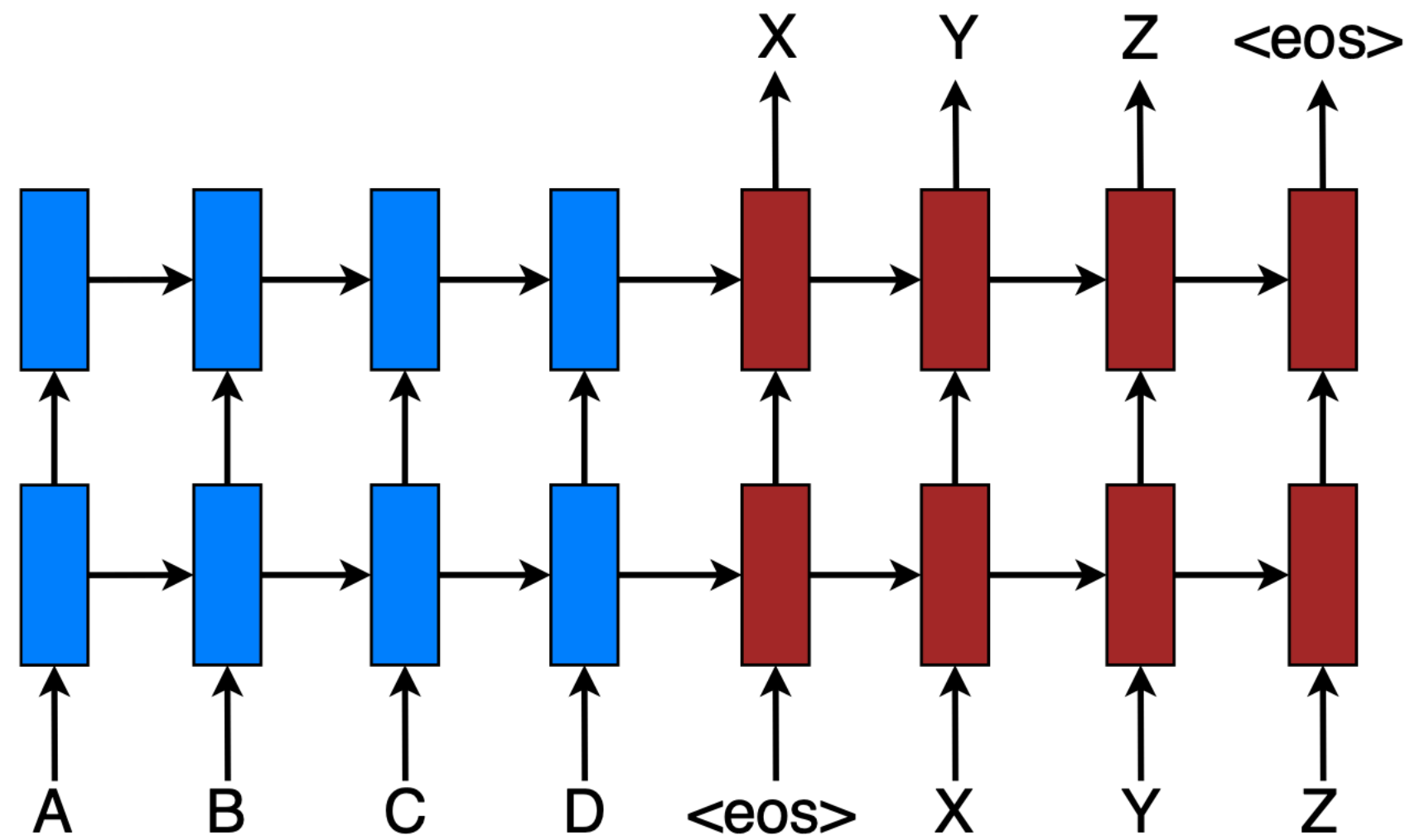

Figure 1: The graphical illustration of the proposed model trying to generate the t -th target word y_t given a source sentence (x_1, x_2, \dots, x_T) .

Effective Approaches to Attention-based Neural Machine Translation



$$\text{score}(\mathbf{h}_t, \bar{\mathbf{h}}_s) = \begin{cases} \mathbf{h}_t^\top \bar{\mathbf{h}}_s & \text{dot} \\ \mathbf{h}_t^\top \mathbf{W}_a \bar{\mathbf{h}}_s & \text{general} \\ \mathbf{v}_a^\top \tanh(\mathbf{W}_a [\mathbf{h}_t; \bar{\mathbf{h}}_s]) & \text{concat} \end{cases}$$

<https://arxiv.org/abs/1508.04025>

$$\frac{\exp(\text{score}(\mathbf{h}_t, \bar{\mathbf{h}}_s))}{\sum_{s'} \exp(\text{score}(\mathbf{h}_t, \bar{\mathbf{h}}_{s'}))}$$

$$\mathbf{a}_t = \text{softmax}(\mathbf{W}_a \mathbf{h}_t)$$

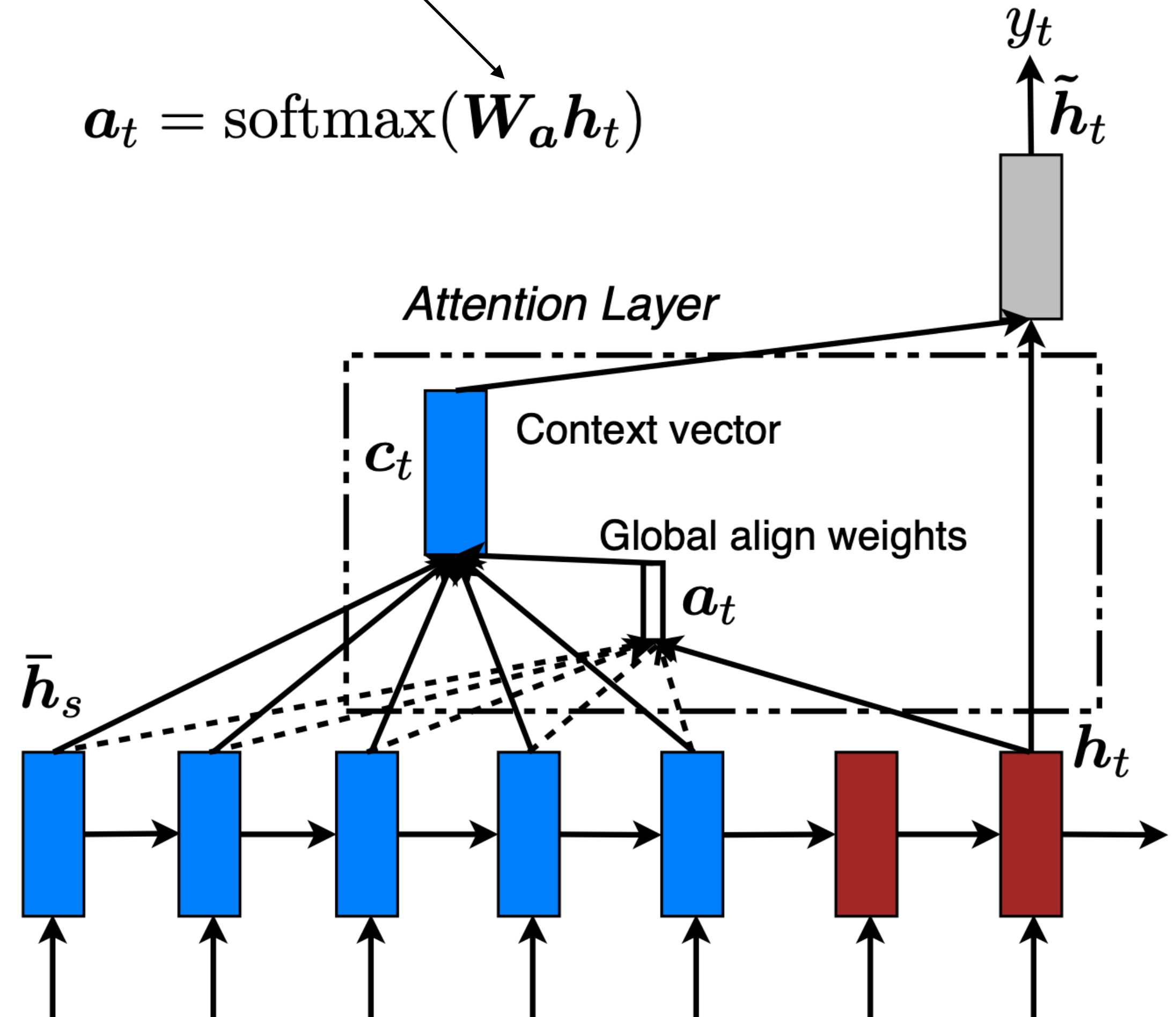

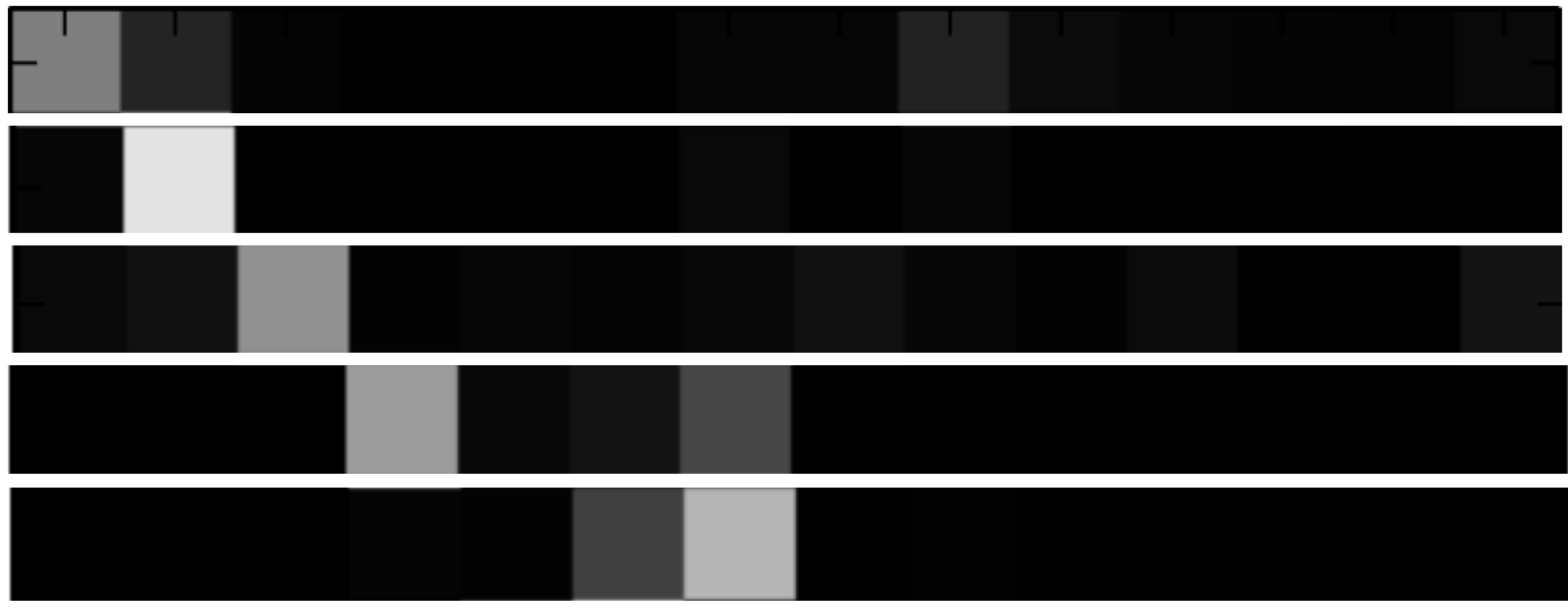

L'
accord
sur
la
zone



[SEP]
L'
accord
sur
la
zone

L'
accord
sur
la
zone
économique

⋮



The
agreement
on
the
European
Economic
area
was
signed
in
August
1992
.

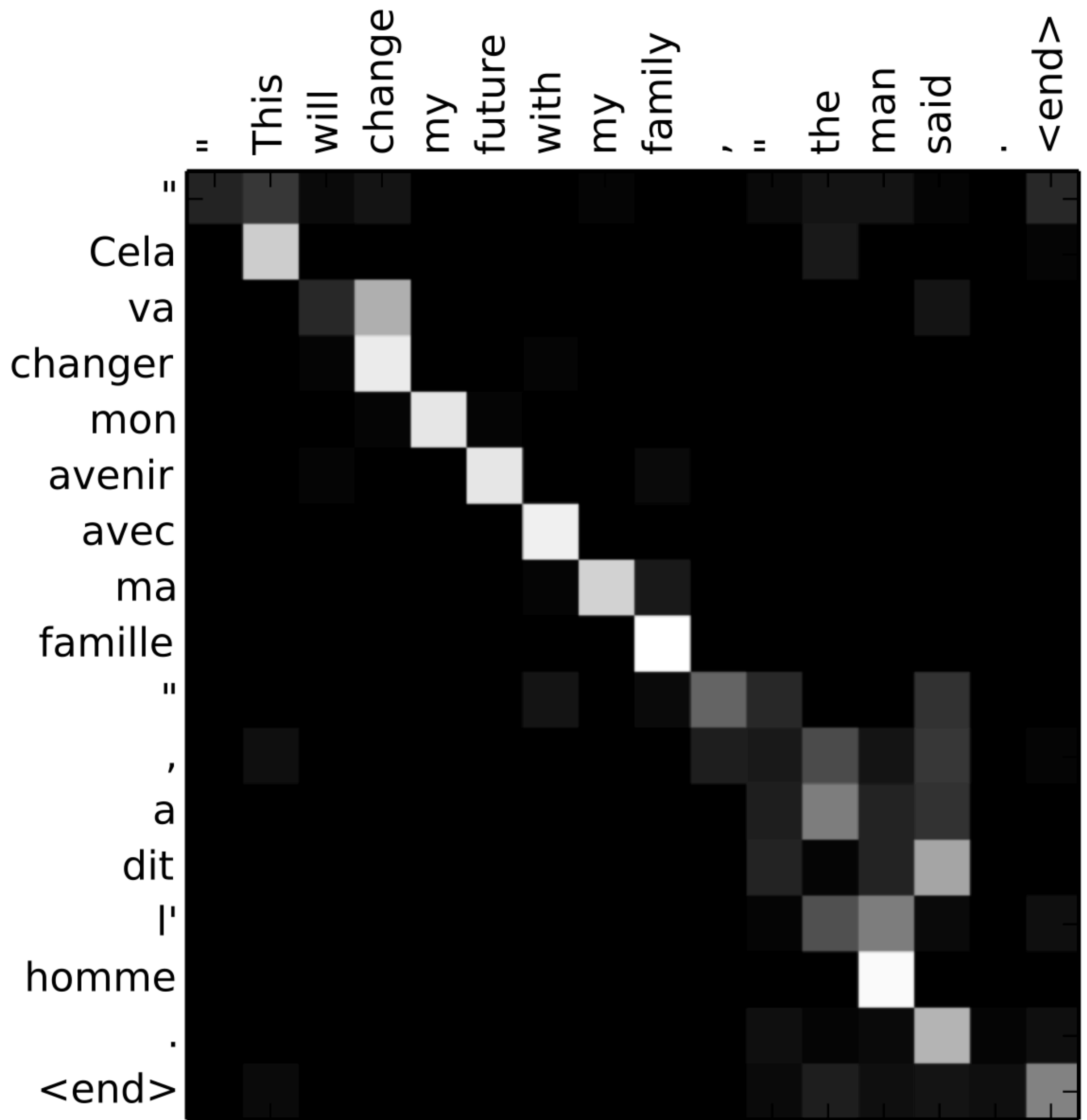

Source

An admitting privilege is the right of a doctor to admit a patient to a hospital or a medical centre to carry out a diagnosis or a procedure, based on his status as a health care worker at a hospital.

No attention

Un privilège d'admission est le droit d'un médecin de reconnaître un patient à l'hôpital ou un centre médical d'un diagnostic ou de prendre un diagnostic en fonction de son état de santé.

With attention

Un privilège d'admission est le droit d'un médecin d'admettre un patient à un hôpital ou un centre médical pour effectuer un diagnostic ou une procédure, selon son statut de travailleur des soins de santé à l'hôpital.

Source

This kind of experience is part of Disney's efforts to "extend the lifetime of its series and build new relationships with audiences via digital platforms that are becoming ever more important," he added.

No attention

Ce type d'expérience fait partie des initiatives du Disney pour "prolonger la durée de vie de ses nouvelles et de développer des liens avec les lecteurs numériques qui deviennent plus complexes.

With attention

Ce genre d'expérience fait partie des efforts de Disney pour "prolonger la durée de vie de ses séries et créer de nouvelles relations avec des publics via des plateformes numériques de plus en plus importantes", a-t-il ajouté.